

/ CONCERTO

design:
Gianantonio Perin
Monica Fernandes



173,8

94









Un Concerto di soluzioni: anche espositore e materioteca.

A concert of solutions: also display and material library.

Un concert de solutions : également présentoir et matériauthèque.

Ein Konzert der Lösungen: beides

Ausführungs und farb-empfehlung austeller.

Un Concerto de soluciones: también display y biblioteca de materiales.



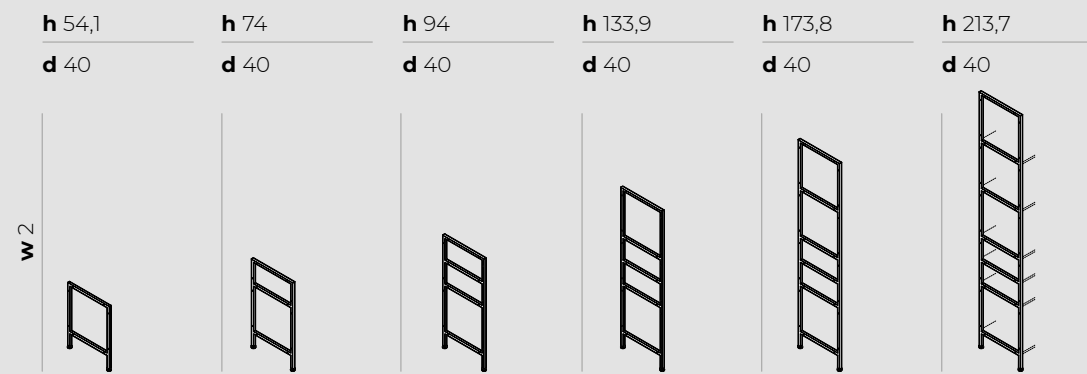

facilità di montaggio
easy to assembly
simplicité de montage
Einfacher Montage
facilidad de montaje

trasformabilità
convertibility
transformabilité
Verwandelbarkeit
transformabilidad

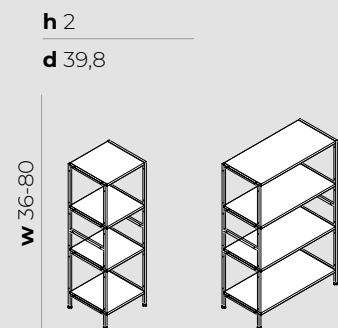

h 37,7
d 1,8

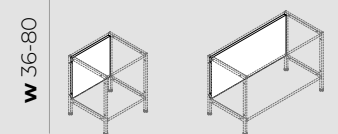

h 39,8
d 40

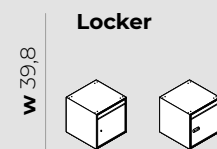

h 57
d 40

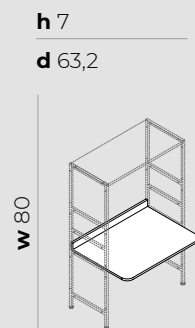

h 31,5
d 2

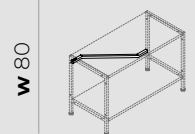

h 39,8
d 40

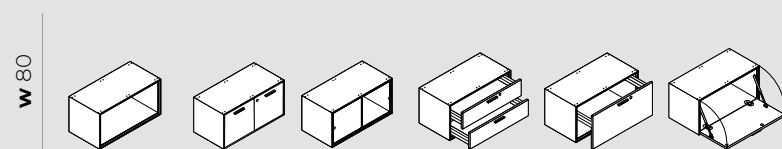

h 45,4
d 40



w 84,4

measure in cm • measurements in cm • mesures en cm • Maße in cm • medidas en cm



sistema di giunzione rapida
quick joining system
système d'assemblage rapide
Schnell Verbindungs-system
sistema de unión rápida

integrabile con Take-Off Evo / Take-Off Country
can be integrated with Take-Off Evo / Take-Off Country
peut être intégré avec Take-Off Evo / Take-Off Country
Es kann mit Take-Off Evo / Take-Off Country integriert werden
Se puede integrar con Take-Off Evo / Take-Off Country

piedino per angolo
corner foot
pied d'angle
Eckfuß
pie de esquina

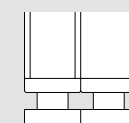

top metallico obbligatorio per Ubi
mandatory metal top for Ubi
dessus en métal obligatoire pour Ubi
Pflichtiger Metall-abdeckplatte für UBI
Tapa de metal obligatoria para Ubi

3 schiene differenti
3 different backs
3 dos différents
3 verschiedene Rückseiten
3 respaldos diferentes

Ubi

integrabile con s18 h 74
can be integrated with s18 h 74
peut être intégré avec s18 h 74
Integrierbar mit S-18 Serie h 74
se puede integrar con s18 h 74

struttura, structure, structure, Korpus, estructura

scrittoio, writing, écritoire, Schreibplatte, escritorio

schiena pannello, back panel, panneau arrière, Rückwand, panel posterior

metallo, metal, métal, metal, metal

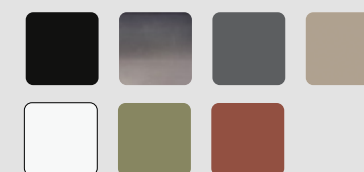

melaminico, melamine, mélamine, melamin, melamina

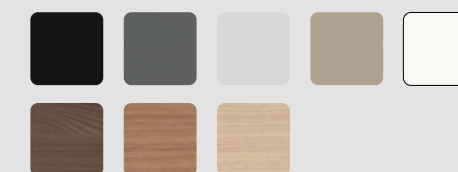

melaminico, melamine, mélamine, melamin, melamina



laccato opaco, lacquered matt, lacqué mat, matt lackiert, lacado mate

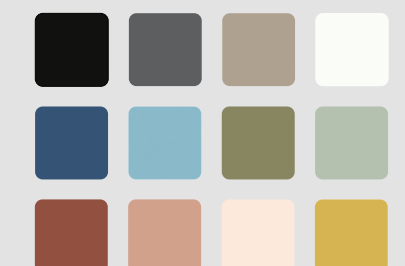

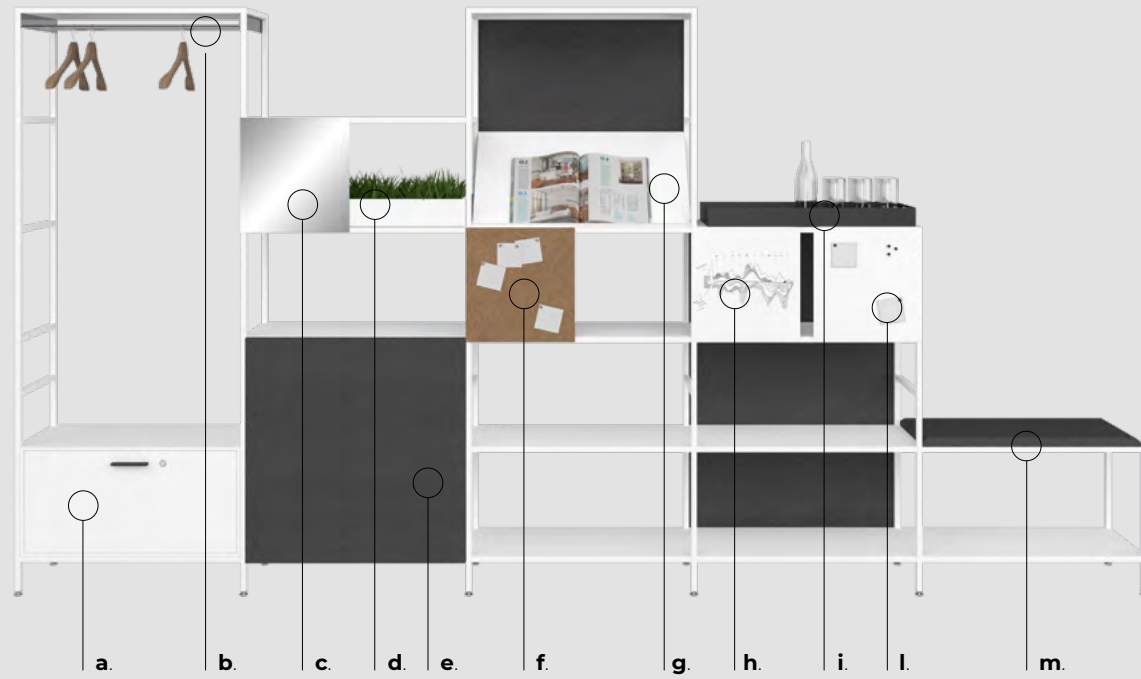

a. Ubi

b. riloga appendiabiti
pull-out coat hanger
portemanteaux extractible
Ausziehbare Kleiderstange
percha extraíble

c. pannelo metallico con specchio
metal panel with mirror
panneau métallique avec miroir
Metallplatte mit Spiegel
panel de metal con espejo

d. contenitore
container
armoire
Behälter
armario

e. B-sound

f. pannelo metallico con sughero puntinabile
metal panel with cork board
panneau métallique avec du liège punaisable
Metallplatte mit Pinnwand aus Kork
panel de metal con corcho perforable

g. espositore inclinato

inclined display
affichage incliné
Quer Aussteller-platte
pantalla inclinada

h. pannelo metallico con lavagna scrivibile
metal panel with writing board
panneau métallique avec tableau inscriptible
Metallplatte mit beschreibbarer Tafel
panel de metal con pizarra grabable

i. vassoio porta oggetti

metal tray
plateau de stockage
Ablagefach
bandeja de almacenamiento

l. pannelo metallico con lavagna scrivibile

metal panel with writing board
panneau métallique avec tableau inscriptible
Metallplatte mit beschreibbarer Tafel
panel de metal con pizarra grabable

m. cuscino h 4,2

pillow h 4,2
coussin h 4,2
Kisse h 4,2
cojín h 4,2

120

MANIGLIE

handles
poignées
Griffe
tiradores

121

SISTEMI DI APERTURA

opening system
systèmes d'ouvertures
Eröffnungs-systeme
sistema de apertura



plastica
 plastic
 plastique
 Plastik
 plàstic

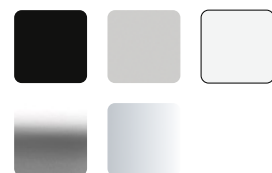

laccato opaco
 matt lacquered
 lacqué mat
 matt lackiert
 laqueado mate

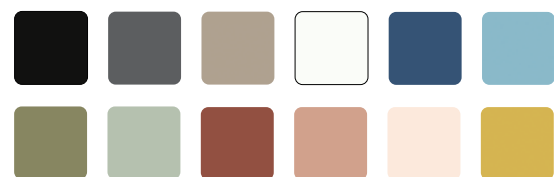

legno
 wood
 bois
 Holzfurnier
 madera

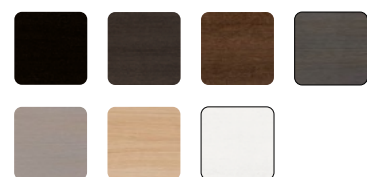

metallo
 metal
 métal
 metall
 metal



metallo
 metal
 métal
 metall
 metal



office A

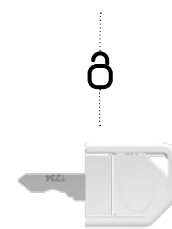

A

cifratura unica
 unique encryption
 chifrage unique
 Gleichschliessende Zahlenschloss
 cifrado unico

office B



B

cifratura unica
 unique encryption
 chifrage unique
 Gleichschliessende Zahlenschloss
 cifrado unico



chiave passepartout
 master key
 la clef passepartout
 Hauptschlüssel
 llave maestra



codice di identificazione chiave/serratura
 key/lock identification code
 code d'identification clé/serrure
 Identifikationscodes Schlüssel/Schloss
 código de identificación llave/cerradura

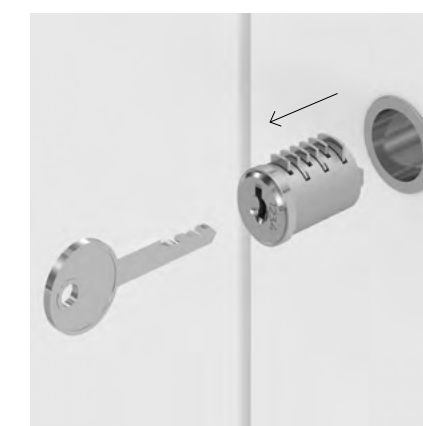

chiave di servizio per estrazione nottolino
 service key for pawl extraction
 clé d'extraction pour barillet
 Werkzeugschlüssel zum Zylinderabau
 llave de servicio para extracción del bombín

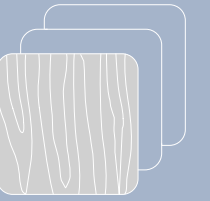

FINITURE E COLORI
finishing and colors
finitions et couleurs
Farben und ausföhrungen
acabados y colores



legno • veneer • bois • Holz • hout • maderá



rovere laccato nero
black lacquered oak
chêne laqué noir
schwarz lackierter Eiche
roble lacado negro

rovere Carbon
Carbon oak
chêne Carbon
Eiche Carbon
roble Carbon

rovere tabacco
tobacco oak
chêne tabac
Eiche Tabak
roble tabaco

rovere grigio scuro
dark grey oak
chêne gris foncé
dunkelgraue Eiche
roble gris oscuro



rovere grigio
grey oak
chêne gris
Eiche grau
roble gris

rovere naturale
natural oak
chêne naturel
Natur Eiche
roble natural

rovere laccato bianco
white lacquered oak
chêne laqué blanc
weiß lackierter Eiche
roble lacado blanco

melaminico • melamine • mélamine • melamin • melamina



nero
black
noir
schwarz
negro

grigio titanio
titanium grey
gris titane
titangrau
gris titanio

grigio perla
pearl-grey
gris perle
perlgrau
gris perla

tortora
turtledove
tourterelle
taubengrau
törtola

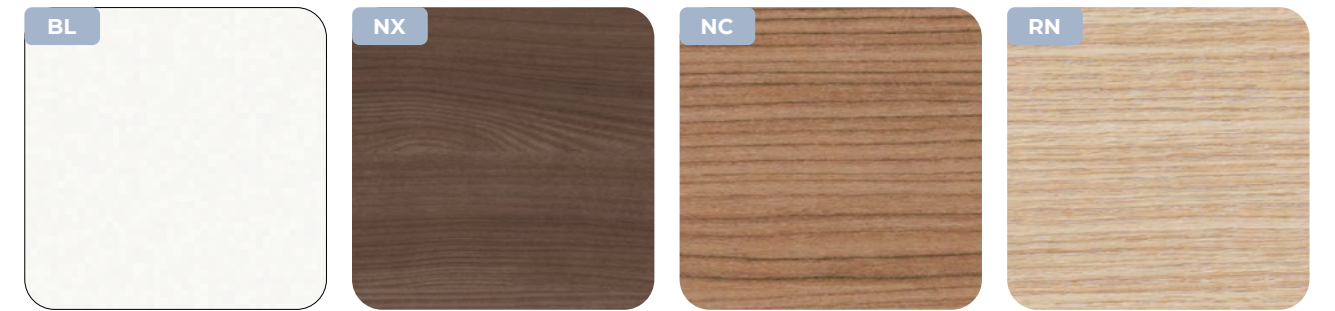

bianco
white
blanc
weiß
blanco

noce Lux
walnut Lux
noyer Lux
lux Nussbaum
nogal Lux

noce canaletto
canaletto walnut
noyer canaletto
Canaletto Nussbaum
nogal canaletto

rovere naturale
natural oak
chêne naturel
Natur Eiche
roble natural



rovere anticato
traditional oak
chêne vieilli
Eiche Antik
roble antiguo

RA
Superficie antibatterica
Antibacterial surface
Surface antibactérienne
Antibakterielle Oberfläche
Superficie antibacteriana



strutture metalliche • metal structures • structures métalliques • metallgestelle • estructuras metálicas

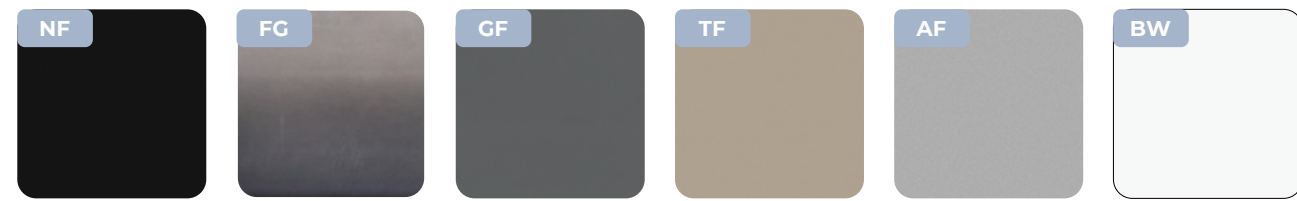

NF
nero
black
noir
schwarz
negro

FG
ferro grezzo
raw steel
métal brut
rohes Metall
hierro bruto

GF
grigio titanio
titanium grey
gris titane
titangrau
gris titanio

TF
tortora
turtledove
tourterelle
taubengrau
törtola

AF
epox alluminio
silver epoxy
epoxy aluminium
epoxy aluminium
epoxidico aluminio

BW
bianco
white
blanc
weiß
blanco



VF
oliva
olive
olive
olive
oliva

CF
terracotta
terracotta
terre cuite
terracotta
terracota

KR
cromo lucido
glossy chrome
chromé brillant
Chrom poliert
cromo brillo

EF
grigio ombra
shadow grey
gris ombre
vulcanschwarz
sombra gris

FG: La finitura ferro grezzo "FG" risalta la natura "industriale" del metallo grazie ad un trattamento protettivo trasparente. Differenze di tonalità, abrasioni, striature e saldature sono tipici della materia prima stessa e delle successive lavorazioni e sono tra gli elementi caratterizzanti del prodotto e per questo non contestabili.

FG: The raw steel finish "FG" emphasizes the "industrial" nature of the metal thanks to a transparent protective treatment. Differences in shades, abrasions, stripes and welds are typical of the raw material and subsequent processes, and are among the characteristic elements of the product, therefore not claimable.

FG: La finition en métal brut "FG" démarque la nature "industrielle" du Métal grâce à un traitement avec une protection transparente. Les différences dans les nuances, les abrasions et les soudures sont typiques de la matière première et des ultérieures process de production et font partie des éléments caractéristiques du produit et donc non contestables.

FG: Das rohes Metall-Finish "FG" sticht besonders hervor der "Industriellen" Natur der Metall durch einer Transparenten Schutz Behandlung. Unterschiede in Farbton, Abrieb, Streifen und Schweissungen sind typisch für den Rohstoff und die nachfolgenden Prozesse und gehören zu den charakteristischen Elementen des Produkts und daher sind nicht anfechtbar.

FG: El acabado de hierro bruto "FG" destaca la naturaleza "industrial" del Metal gracias a un tratamiento protector transparente. Las diferencias en los tonos, abrasiones, rayas y soldaduras son típicas de la materia prima y los procesos posteriores y se encuentran entre los elementos característicos del producto y, por lo tanto, es indiscutible.

laccato opaco • lacquered matt • laqué mat • matt lackiert • lacado mate

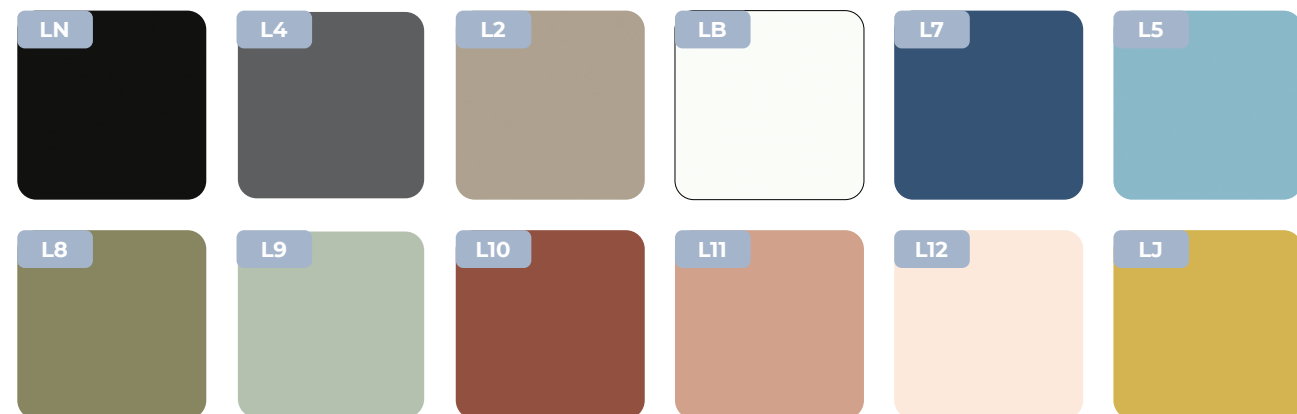

vetro temperato retrolaccato • back-lacquered tempered glass • verre retro-lacqué trempé • sicherheitsglas rückseitig lackiert • vidrio retrolacado templado
C_ (lucido • glossy • brillant • poliert • brillo) S_ (opaco • matt • opaque • matt • mate)

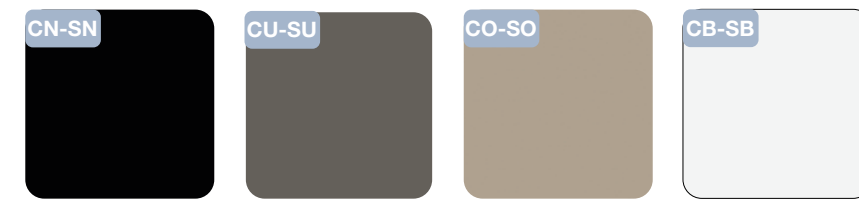

vetro temperato • tempered glass • verre trempé • sicherheitsglas • vidrio templado



plastica • plastic • plastique • Plastik • plástico

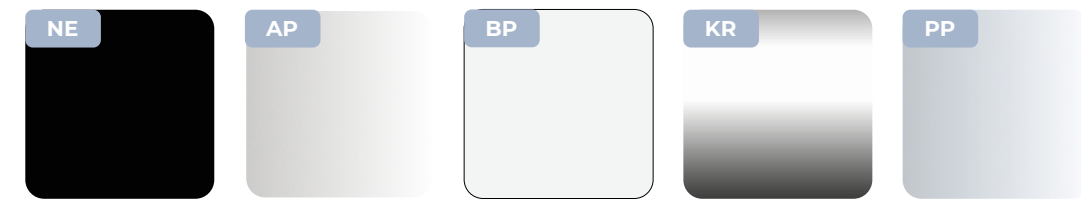

metacrilato • methacrylate • méthacrylate • Methacrylat • metacrilato





tessuto • fabric • tissu • stoff • tejido

MIRAGE

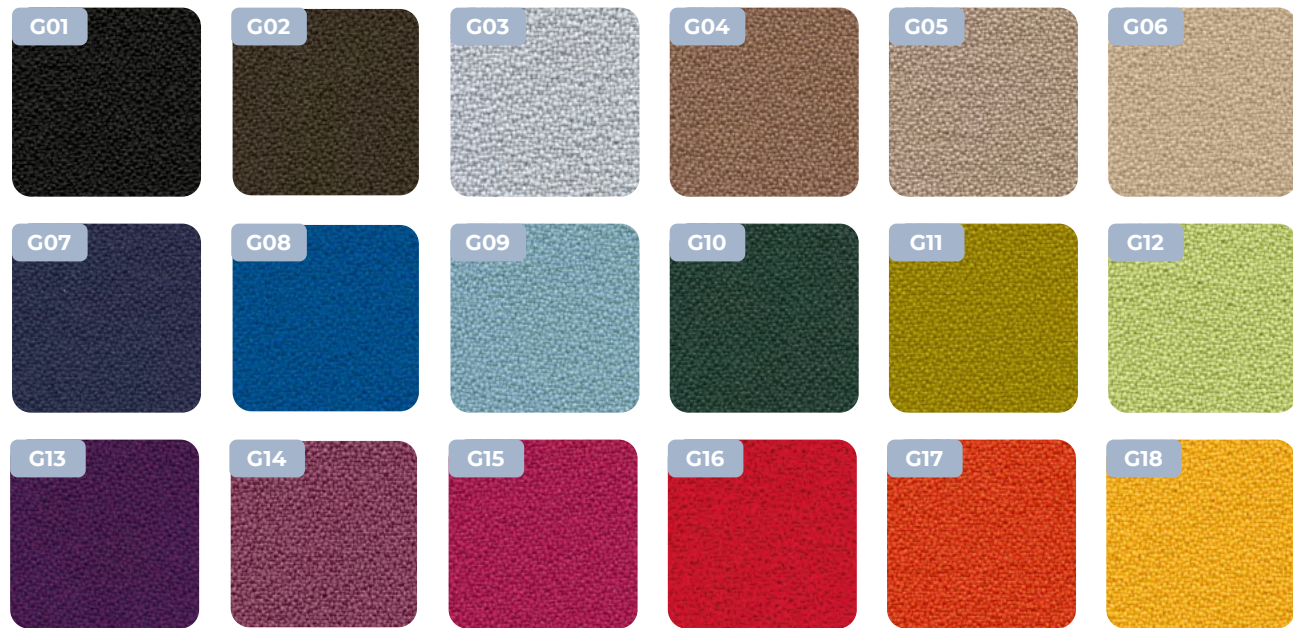

NEMI MELANGE

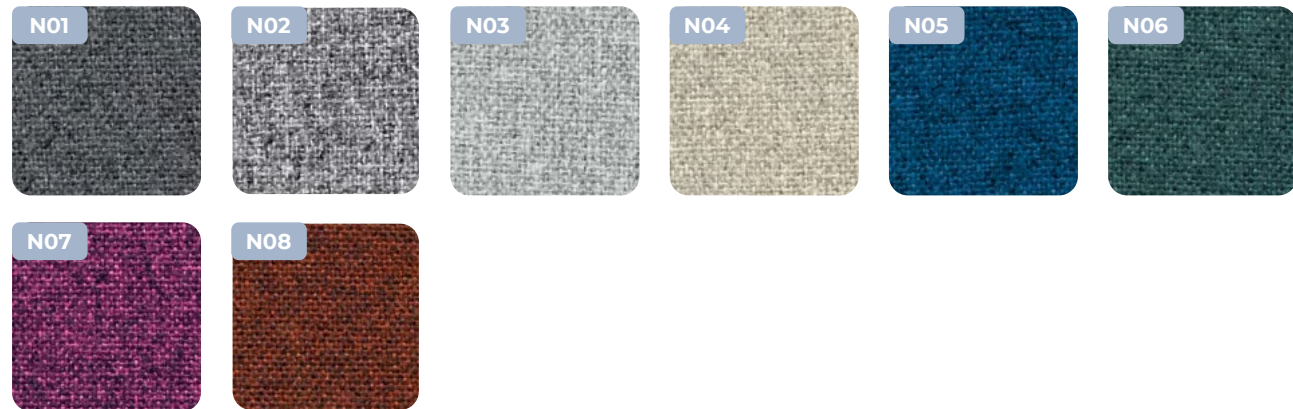

FENICE



CONVERT MEL 4000

